

1985

*California  
Building  
Officials*

Seminar on  
Handicapped  
Accessibility &  
Adaptability  
Standards

**Training  
Workbook** Spring 1985

Technical materials and illustrations for this manual  
were produced by:

Independent Housing Services  
25 Taylor  
San Francisco, CA 94102  
415/ 441-7713  
TDD 441-6791.

# Seminar Agenda

## Table of Contents

Introduction	3
Accessibility v. Adaptability	4
Needs of a Changing Population	5
Purpose of the Regulations	6
Goals of the Regulations	8
Background on the Title 24 Process	10
Resource Materials	10
The Accessibility/Adaptability Standards	11
Scope	16
Circulation Components	25
Height Components	26
Bathroom Components	32
Kitchen Components	37
Typical Questions & Answers	39
A Note on Priorities	39

## Accessibility v. Adaptability \_\_\_\_\_

Most designers are familiar with the old ANSI accessibility standards for public buildings. These and variants on them have been used in HUD-subsidized buildings for many years to create a percentage, usually 5% or 10%, of units in a large project which are "handicapped accessible." Handicapped has often been used to refer specifically to that portion of the population who use wheelchairs regularly. "Accessible" housing requires the installation of grab bars at the tub and water closet, five-foot diameter turning radii in the bathroom and other single-exit areas, lever door hardware, lowered kitchen counter tops, etc. These units are more expensive to build than others, have a somewhat institutional appearance that makes them difficult to market, and are adapted to the specific needs of a very particular occupant group. They are not well-suited to many able-bodied people nor to many. They cannot easily be retrofitted to the use of a different group, as the tenancy of a building changes.

Adaptable housing is an entirely different concept created to meet the needs of all occupants. Adaptable housing is initially accessible in terms of entry and circulation, and can be adapted to the use of people with a variety of disabilities through minor low cost modifications after construction.

To an able-bodied occupant, an adaptable home appears no different than any other, except that circulation may be somewhat easier. To a person in a wheelchair, the home may be adapted to his or her use by lowering a work area in the kitchen to be comfortably used when seated. To a person with other physical disabilities who does not need a lowered work area, the home may be adapted in other ways. To an elderly person with increasing mobility limitations, the home may be adapted through the installation of grab bars in the bathroom. The essential performance standard for adaptable home design is to allow an able-bodied person or a person with mobility limitations the ability to get into and out of the home, to circulate freely within it, and to perform basic daily function in the kitchen and bathroom. Title 24, part 2, of the California Administrative Code, provides a minimal prescription for achieving this design goal. The careful and creative designer can do much more to widen the usefulness of housing within the programmatic and cost constraints of his or her project.

## The Needs of a Changing Population \_\_\_\_\_

The American people are growing older.

Our population over 60 years old has risen from 12% in 1950 to over 15% in 1980. The increase will become significantly greater during the balance of the 1980s. This older population is a prime house buying group. Their older years are healthier and more productive. If their homes can be quickly and cheaply adapted to the increasing mobility limitation that is a part of aging, then they will be able to prolong their comfortable years at home, avoiding institutionalization or the displacement to different housing with fewer stairs, etc.

There is a direct relationship between age and physical disability. Fewer than five percent of children are physically disabled. For young adults, this just about doubles to 10.5 per cent. At age 64, 29% of the population is disabled, and by age 85, over 50% have severe physical disabilities.

The physically disabled population has changed significantly, too. Improved medical care allows many to live long and productive lives who once would have died of their disease or injury. Independent living -- at home, not in an institution or back room -- requires access to school, to work, to friends' homes, shopping, public transportation.

It is instructive to look at just what mobility limitations the built environment should accommodate. A study by the National Center for Health Statistics shows that of those people who cannot perform basic physical activities, people need help in the following activities:

walking	50.4%
going outside	64.7
bathing	52.1
dressing	42.0
using the toilet	26.9
getting in or out of bed or chair	27.7
eating	12.6

These percentages total more than 100% because most people have more than one activity which they could not perform at all or without assistance.

For those who need help with home management activities, the study showed this breakdown:

shopping	76.6%
doing chores	72.8
preparing own meals	47.3

There are significant differences between the sexes. Men suffer more industrial and war injuries at a younger age, and suffer higher rates of heart disease than women. Women live longer and have more disabilities in old age. There are also geographical differences. One California study showed that urban and rural populations have higher disability rates than the suburban population. This may be partly because suburban people move to larger cities for medical treatment once disabled.

Like the aging, the disabled are not only living longer, but have increased expectations for their own ability to fully participate in society on the job, at school, or socially.

The purpose of adaptable housing is to design housing for the largest market possible, regardless of age or physical condition. Adaptable housing as we now understand it is the first attempt to tailor housing to the changing needs of our much older population. There is little doubt our understanding of this will continue to improve as we learn from these first steps .

## Purpose of the Regulations \_\_\_\_\_

The purpose of these adaptability regulations was to recognize the housing needs of the wide range of state residents and address specific design points which would open up new rental housing units to those outside the norm. The regulations place no burden on the presently able-bodied but do make possible a major shift in usability should the renter become disabled, is currently disabled, or has general mobility problems associated with old age. To spread the costs of change equitably, a cost cap of \$600.00 (\$740 in January, 1985) per dwelling unit was agreed to in the development of these standards. The adjustments to a unit to service different renters are described thoroughly in the following text and should be possible with a minimal cost and in a short period of time. These changes will allow more people to remain in their

homes despite the vagaries of chance. Elderly people will not be displaced if they suffer a heart attack or broken hip, physically disabled will for the first time have open options where they can look for housing, the able-bodied will find homes more comfortable with greater care being given to understanding body use.

## Performance Goals of the Regulations \_\_\_\_\_

The regulations attempt to ensure that all effected rental housing will allow comfortable use by a person in a wheelchair, or someone who has mobility or range of motion limitations.

A new renter should be able to move from the edge of the site, through all public areas indoors and out, to his or her specific unit's main entrance and through all rooms of the apartment. The door opening widths must be wide enough (32") to admit a person using a wheelchair or walker. The corridors should be spacious enough (44") to make a 90 degree turn in a wheelchair through a side doorway, the door handles should be usable by those with limited grasping ability, and shelves, control switches, outlets, and thermostats should be operable within a comfortable reach range for a standing or seated individual.

The use of a home's functional areas are usually taken for granted--except when a shelf is too high to see its contents, when the toilet paper dispenser is not really within grasp, when the bedroom doorway won't allow an individual to pass through, or when the electrical outlet is too low on the wall. Those things which may be inconvenient or annoying to the able-bodied may be an insurmountable obstacle for the wheelchair user or the arthritic person who cannot bend, stretch or grasp as well or who must control a steel wheelchair. A person using the kitchen needs safe and comfortable access to stove, sink and refrigerator, needs adequate counterspace to prepare foodstuffs, and reachable storage for pots, implements and food. The difference in height between a seated and standing person is approximately 15". This difference in eye height makes shelf location and placement of switches important. If a person has difficulty bending down or reaching up, his or her range of comfort and safety in getting at shelves is more limited than an able-bodied person. Most wheelchair users have a different center of gravity than a standing person and reaching below this center of gravity may create an extremely.

6  
unstable position. A person suffering stroke effects may be in an unsafe situation if a stool is needed to reach upper shelf storage.

The kitchen, where the bulk of daily high activity takes place, is made safer and more usable by these regulations and will be discussed in detail further in the text under Kitchen Design.

Another high activity area is the bathroom where one uses the sink, toilet and either a tub or shower. In this room the most important focus is the maneuvering room needed for different body function. For a wheelchair user to be safe and comfortable in performing these necessary daily activities, he must be able to go into the bathroom, shut the door, use toilet, use the sink, and then reopen the door and exit. Because bathrooms rarely are given more than residual spaces, the maneuvering area needed must be critically eyed. A person using the toilet from a wheelchair needs space in front or on the side for transfer. The sink, lavatory or vanity must be usable from a front position with hot water and cold water faucet controls reachable from a wheelchair. A space would be needed beside the tub/shower of sufficient size (30" x 48") to allow parallel parking of the wheelchair for transfer. The shower/bathtub would then be usable from a seated position. Hot water and cold water controls would be reachable and the shower head could be adjusted, either through a fixed head height of 5'-0" or with hand-held shower attachment and 5 foot hose length so that one could reach the entire body with the spray from a stationary seat. If the maneuvering space within the room is inadequate, it will be unsafe to use the fixtures because a wheelchair user is limited in any movement outside the chair, and a person using a walker, cane or assistive device will need room to shift weight and balance when positioning properly to perform a specific bathroom function. Design and cost implications of necessary maneuvering space will be discussed in the bathroom section of the text.

# Background on the Title 24 Process

## The Codes.

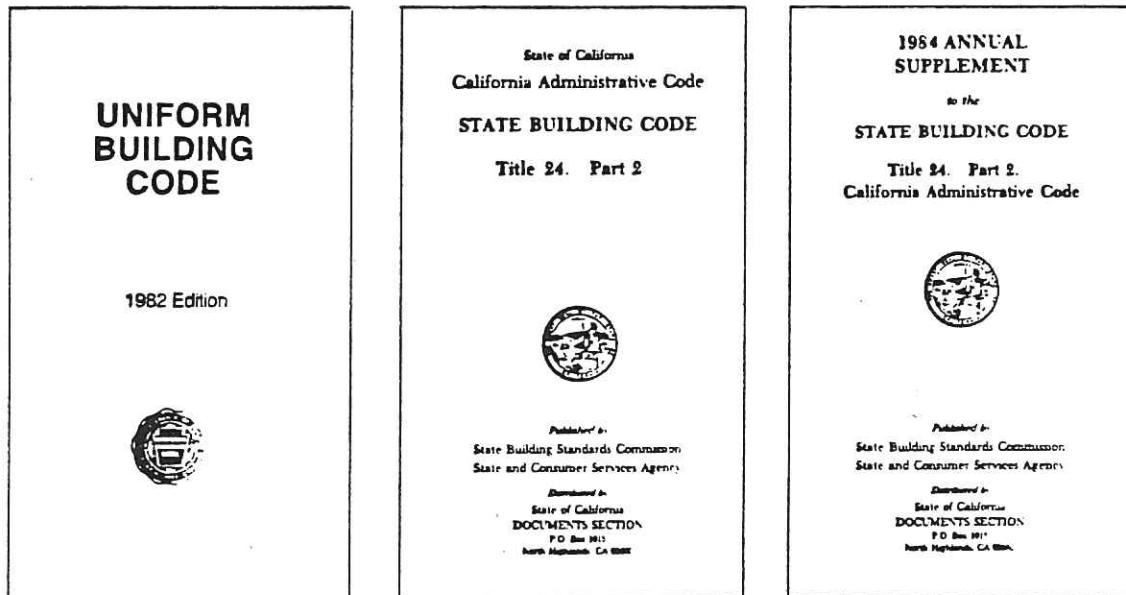

The Accessibility/Adaptability regulation for new apartment buildings were adopted by the State Department of Housing and Community Development, and were approved by the State Building Standards Commission in December 1983. The standards were published in the 1984 Annual Supplement to the State Building Code on March 15, 1984.

The State Building Code contains amendments which have been made by state agencies to the Uniform Building Code, which is published by the International Conference of Building Officials. All state agencies which have programs including building standards are required to develop their standards so that they closely follow the requirements of the Uniform Building Code. Many agencies, such as the Department of Housing and Community Development, which has jurisdiction over residential occupancies, adopt the Uniform Building Code by reference. That is, they simply refer the designer or enforcement official to the Uniform Building Code for construction requirements.

When a state agency determines a need for amendments or additions to the Uniform Building Code, they adopt such changes after a public hearing process. These changes are reviewed by the State Building Standards Commission



which analyzes the proposed code based on an established criteria. When approved by the State Building Standards Commission, the code changes are published in an annual supplement to the State Building Code, which represents Title 24, Part 2 of the California Administrative Code.

Once published in the State Building Code a local government must adopt the provisions of the code. This action cannot be taken until six months have passed from the publication date of the Annual Supplement to the State Building Code. This six month delay is largely for the benefit of the construction industry. It allows designers, builders, and developers to become familiar with elements of the code and also serves to clear the pipeline of projects which have been designed to the previous building standard.

Six months after publication of the Annual Supplement, and within 1 1/2 years of publication, a local government may adopt the amendments to the Uniform Building Code which are included in the Annual Supplement. If they are not adopted by the local government within 1 1/2 years of publication they automatically become effective at the end of that period.

It is important to note that some aspects of the Accessibility/Adaptability regulations appear in other parts of Title 24. The regulations contain a limited number of electrical requirements, which appear in Part 3 of Title 24. There are also a limited number of plumbing requirements, which appear in Part 5 of Title 24.

## Resource Materials

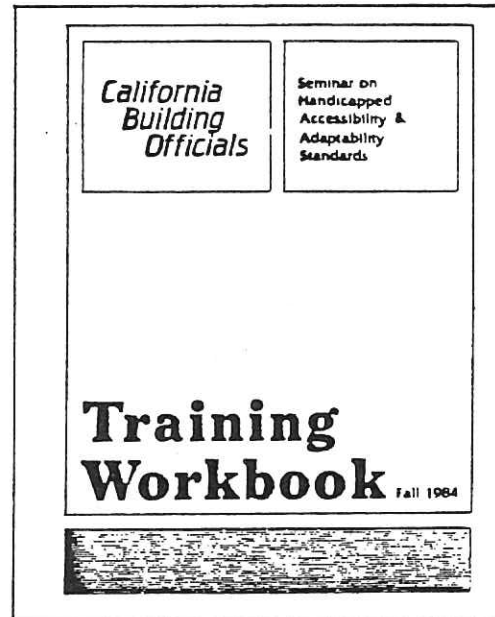
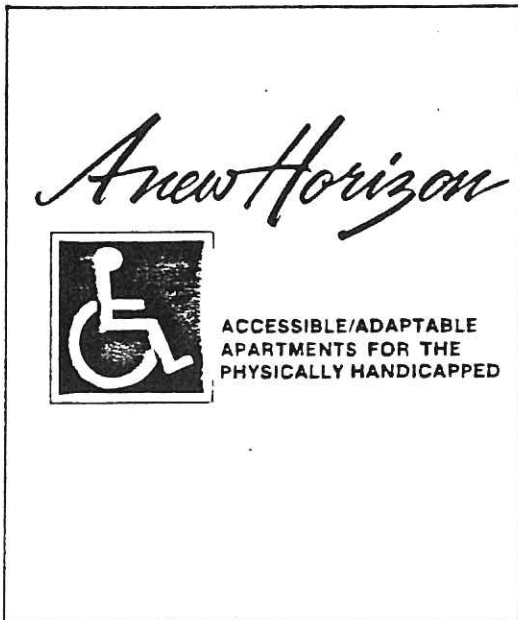

Two publications have been prepared which attempt to promote a thorough understanding of these new regulations. The first, *A New Horizon*, is published by the Department of Housing and Community Development.

The first part of this guide explains elements of the standards in nontechnical language. The second portion of the publication reprints the text of the standards. Additional copies of *A New Horizon* may be ordered from the Department of Housing and Community Development, Division of Codes and Standards--Administration, Post Office Box 1407, Sacramento, CA 95807, (916) 445-9471.

California Building Officials has published a **Training Workbook** to serve as both an teaching aide during their seminar program, and as a resource for future reference. The CALBO publication contains selected reprints of the standards, clarifying commentary, and forty-three illustrations.

# THE ACCESSIBILITY/ADAPTABILITY STANDARDS

## Workbook Organization

To promote an understanding of these regulations, this workbook contains reproductions of the HCD Accessibility/Adaptability Standards as they appear in the 1984 Annual Supplement to the State Building Code. The Department of Housing and Community Development's publication "A New Horizon" contains a complete reprint of the standards. This workbook contains only those points illustrated during the training seminars. In association with the actual language of the standards, illustrations and narrative are included which help to explain and interpret the standards.

Code section numbers appear above each passage of the standards which are reprinted in this workbook. The page number in which the code section appears in "A New Horizon" also appears above each passage in the following format (NH A-5) which references New Horizon, page A-5.

## Scope of Regulations

---

2-105 (b)9

NH A-1

Application— Hotels, motels, lodging houses, apartment houses, dwellings, employee housing, and factory built housing. Access and adaptability requirements for the physically handicapped shall apply to all privately funded apartment houses of five (5) or more dwelling units constructed or approved for construction after the effective date of these regulations, excluding from these regulations Condominiums, Co-ops and Town Houses that are used for individual ownership.

Apartments  
5 or more units

The first sentence of the standard's application section may be misleading to those unfamiliar with state housing law. This sentence simply refers to those areas over which the Department of Housing and Community Development has jurisdiction. The accessibility/adaptability regulations do not apply to all of the building types listed in the first sentence of this paragraph; they only apply to privately funded apartment houses having five or more dwelling units.

There is no definition of Town House included in the standards. The intent of the Department of Housing and Community Development was to exempt those Town House projects which are two-story, single-family attached units having 2-hour fire wall construction and an

ownership of the airspace. Apartment units constructed in the two-story townhouse style would have to comply with these regulations if they contained all of the elements of a dwelling unit on their accessible floor. These elements include a bathroom, kitchen facilities, living area, and sleeping area. If these elements are present, the adaptability regulations would be in force on the accessible floor only.

2-105 (b)9(A)

NH A-1

To determine the total number of dwelling units affected by these regulations, the total number of buildings on a building site shall be considered as one building.

Buildings per site

While the standards state that the total number of buildings on a site shall be considered as one building, the intent of the Department of Housing and Community Development was that the total number of apartment buildings on the site are to be considered as one building. Apartments, as defined by the Uniform Building Code, contain three or more dwelling units.

Figure 1 illustrates a project that would not be subject to these regulations because there are less than 5 apartment units on the building site; figure 1 contains only 4 apartment buildings on the site.

Figures 2 and 3 illustrate a two-phase project built on the same parcel. Even though only four apartment units are built in the first phase of the project, all eight units would be subject to the standards because there are more than five apartment units that will occupy the site.

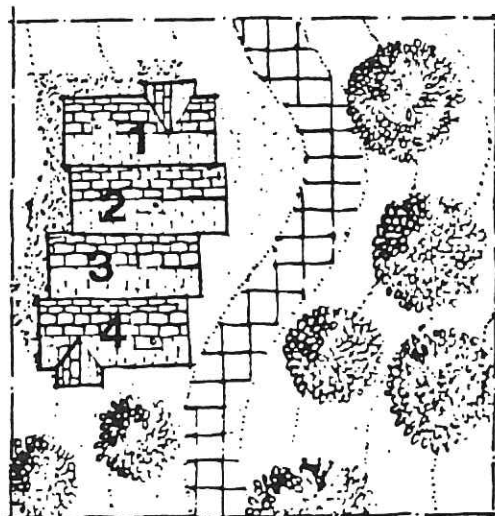

unaffected  
less than 5 apartment units

Figure 1

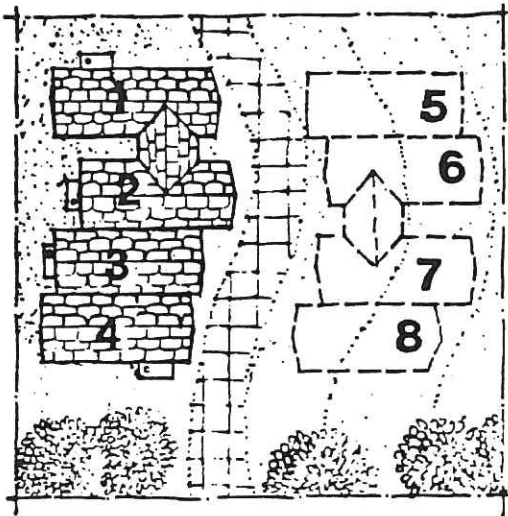

phase 1

affected

Figure 2

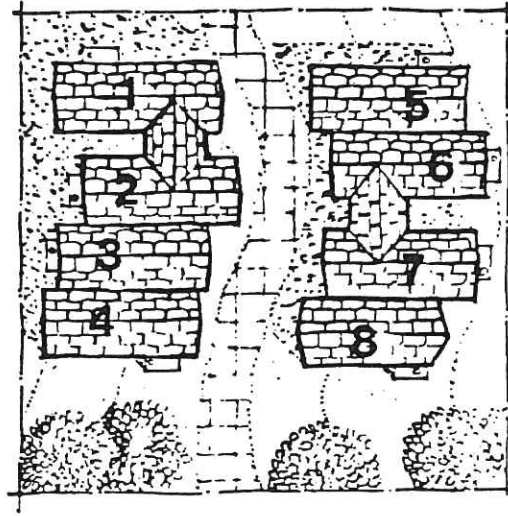

phase 2

affected

Figure 3

2-105(b) 9(B)

NH A-1

Nothing in these regulations shall be construed to require an expenditure in excess of \$600 per adaptable dwelling unit, based on January, 1981, "ENR US-20 Cities." Average construction cost index of 3372.02 ("Engineering News Record," McGraw Hill Publishing Company) for access and adaptability for the physically handicapped.

A builder/developer shall be required to expend up to \$600 per adaptable dwelling unit if necessary to comply with the access and adaptability features for the physically handicapped.

NOTE: For exceptions relating to access and adaptability requirements for the physically handicapped, see Sections 2-1213(b) Ex. 2 and 3.

Cost cap

The regulations contain a provision for a cost ceiling. The regulations do not require a builder to spend more than a certain amount per adaptable dwelling unit. The cost cap was established at \$600 in 1981 and increases annually based on the "ENR US-20 Cities" index. The cost ceiling as of the January 1985 is \$740. Jurisdictions may update the index as often as twice per month.

2-105(b) 9(C)

NH A-1

The requirements for access and adaptability for the physically handicapped shall not apply to the construction of new apartment house projects which received approval by an advisory agency or other appropriate local agency on or before six (6) months following the publication date of these building standards, provided application for the permits to construct the new apartment house projects are submitted or filed on or before 12 months following the publication date of these building standards.

For the purposes of these building standards, "approval" includes but is not limited to, approval or conditional approval of a tentative subdivision

Pipeline exemption

or tentative parcel map or parcel map pursuant to the Subdivision Map Act (Division 2 commencing with Section 66410, or other permit for an apartment house project.)  
 Enforcing Agency—Local building department or the Department of Housing and Community Development.

In order to prevent a hardship for apartment projects where some development and design activity has already occurred, the regulations contain a clause which attempts to provide a "grandfather" exemption for certain projects. To qualify for this pipeline exemption, an apartment project must have received some form of local government approval prior to September 15, 1984. Local approval includes the conditional approval of a tentative parcel map. A project EIR would not constitute such approval. If some form of local approval has been received, a building permit must be applied for prior to March 15, 1985. Projects which have submitted plans to their building department prior to this date, and have received necessary local approval before September 15, 1984 would be exempt from the regulations.

**PIPELINE EXEMPTION**

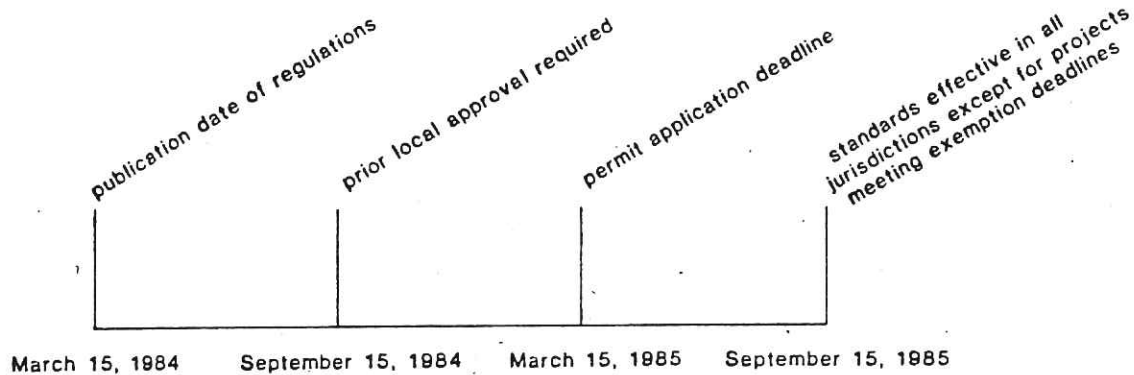

**2-1213(b)**

**NH A-5**

**Living Accommodations.** All publicly funded living accommodations, as defined, on accessible floors and primary entrance floors constructed or approved for construction after the effective date of these regulations, shall comply with the following provisions:

**NOTE:** Also applies to privately funded apartment houses and buildings and structures used in part for three or more apartments.

**EXCEPTION NO. 2:** When public sidewalks, easements or other similar paths of travel fronting a building, in which is located a "primary entrance", as defined under subsection 2-417(k), has a slope of greater than 15% gradient (1 in 6.67) the provisions of this section need not apply.

**EXCEPTION NO. 3:** When a primary entrance is above or below grade and the first dwelling unit nearest to grade of living accommodations consisting of 5 or more units per building, is effectively a story above or below grade, the provisions of this section need not apply unless such dwelling unit is accessible by means of an elevator, ramp or lift to and from a primary entrance.

accessible units only

Grade exemption

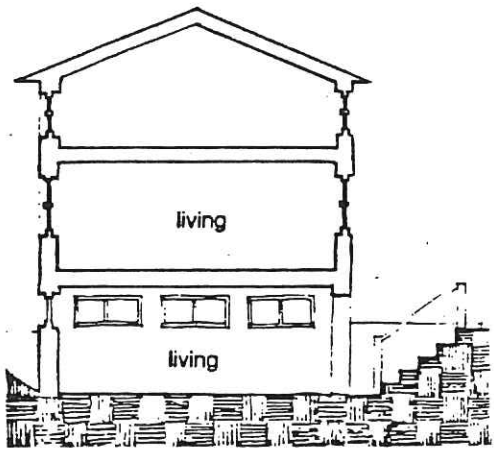

unaffected

Figure 4  
below grade

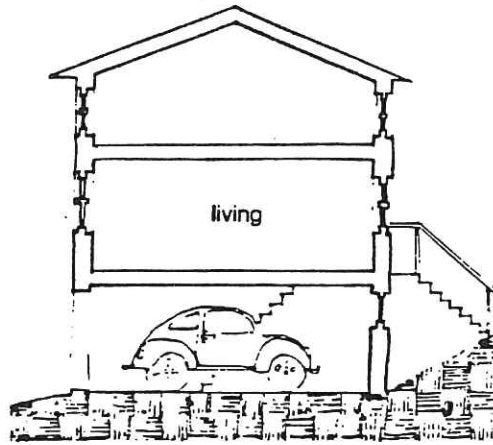

unaffected

Figure 5  
above grade

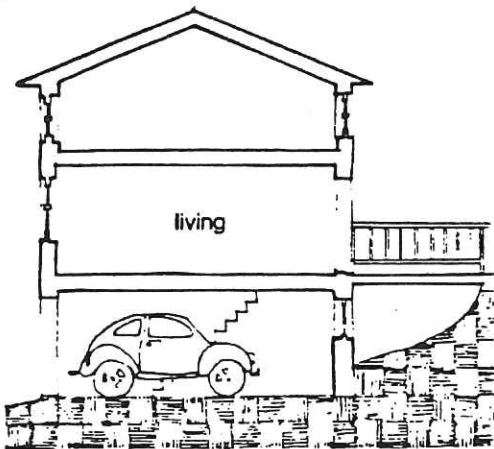

affected

Figure 6  
accessible

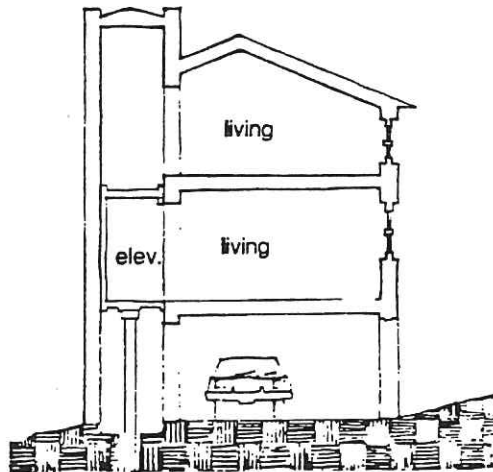

affected

Figure 7  
accessible

When the entrance to an apartment is above or below grade it is exempt from the provisions of these standards. The 1982 Uniform Building Code states that a story above grade is six feet above grade, and a story below grade is four feet below grade. Grade is considered the lowest point within 5 feet of the structure, or at the property line, whichever is closer.

While the grade of a site may exempt an apartment building from these standards, those wishing to make their units accessible can take steps to ensure that site development is shaped to minimize exclusion of any tenants. Grading to reduce slope at entry points may require more earth moving, but it can result in fewer stairs or shorter ramps so the costs of grading may be offset. Privacy from the street may be achieved through design which includes higher windows rather than a higher first floor elevation. Ramps can be made shorter if built against a gradient and concrete landings can be designed economically so they serve two or more units at once (Figures 4,5,6,7).

## Circulation Components of Regulations \_\_\_\_\_

2-417(c)

NH A-3

**Path of Travel.** Path of travel is a passage that may consist of walks and sidewalks, curb ramps, and pedestrian ramps, lobbies and corridors, elevators, other improved areas, or a necessary combination thereof, that provides free and unobstructed access to and egress from a particular area or location, for pedestrians and/or wheelchair users.

Path of travel

2-3301(m)

NH A-10

**Entrances.**

1. All primary entrances to buildings and facilities shall be made accessible to the physically handicapped.
2. **Temporary Restrictions.** During periods of partial or restricted use of a building or facility, the entrances used for primary access shall be accessible to and usable by physically handicapped persons.
3. **Recessed Doormats.** Recessed doormats shall be adequately anchored to prevent interference with wheelchair traffic.

Entrances

In the Entry and Path of Travel sections of the code the intent is to clearly describe the necessity of opening up all areas of the site where a tenant is likely to go, from sidewalk to bedroom. A tenant, whether able-bodied or disabled, will want an open option to participate in any function that is held, whether in the community kitchen, an outdoor seating area, or indoor activity center. Additionally there is the expectation by all tenants to put trash in the garbage chute, check for mail, pay bills in the manager's office, and use a public laundry room where it exists (Figures 8,9,10,11). If community areas are in the same building as residential occupancies, they



are within the scope of the HCD regulations. If community areas are located in a separate building, there are within the scope of regulations of the State Architect.

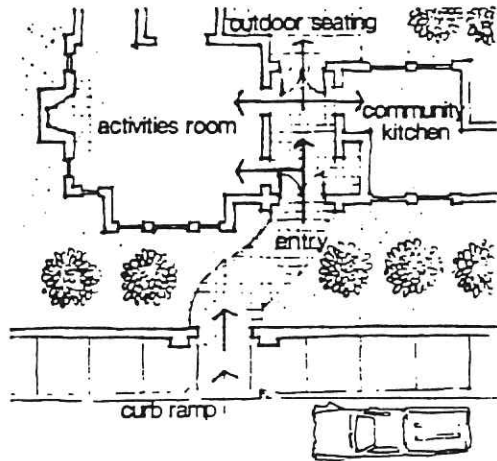

Figure 8

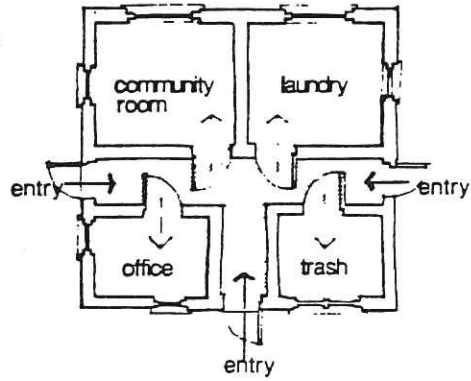

Figure 9

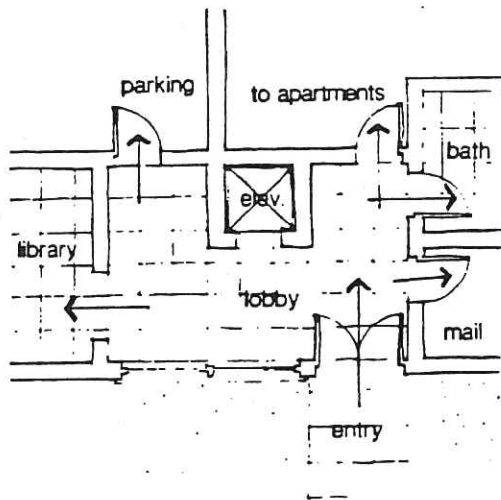

Figure 10

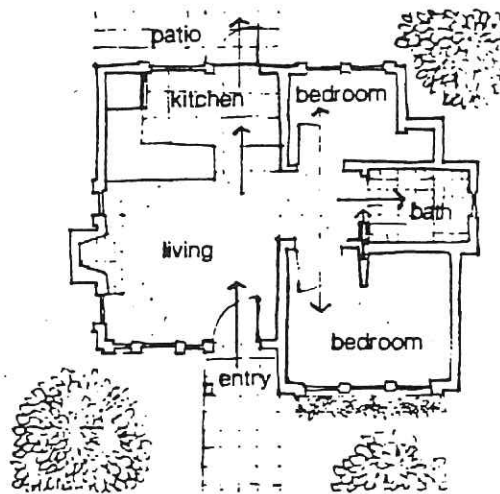

Figure 11

**Change in Floor Level at Doors.**

**Thresholds.**

A. The floor or landing shall be not more than 1/2-in (12.7 mm) lower than the threshold of the doorway.

EXCEPTION: Subsection 2-3303(i)1A shall not be enforced retroactively.

B. Change in level between 1/4-in (6.35 mm) and 1/2-in (12.7 mm) shall be beveled with a slope no greater than 1:2. Change in level greater than 1/2-in (12.7 mm) shall be accomplished by means of a ramp.

NOTE: See Section 2-3306.

Thresholds

Thresholds should be designed to minimize elevation change. Most wheelchair users have difficulty with any more than a 1/4" elevation change, and only the athletic can get over a 1/2" change. Sliding doors need to be thought out carefully because of the deep bottom track (Figures 12,13).

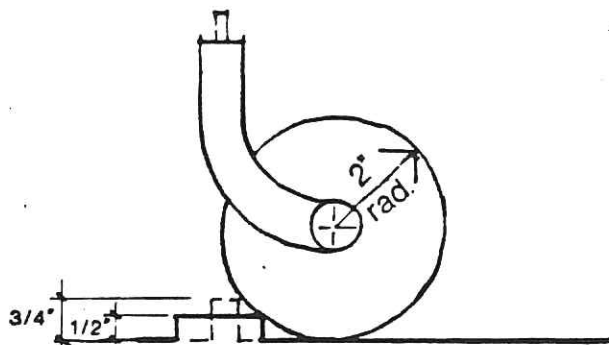

5" CASTER

Figure 12

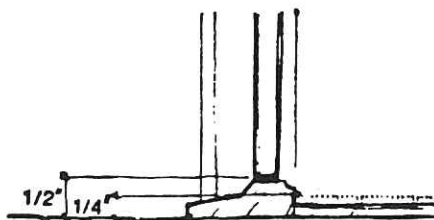

THRESHOLD SECTION AT JAMB

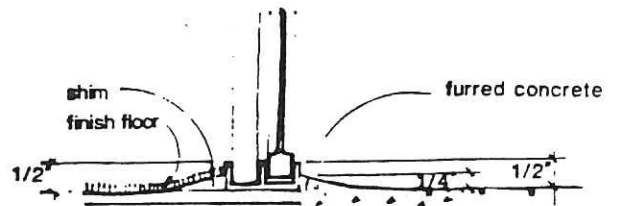

SLIDING DOOR SECTION

Figure 13

**Handrails.**

**1. Required Handrails.** Stairways shall have handrails on each side, and every stairway required to be more than 88-in (2,235.2 mm) in width shall be provided with not less than one intermediate handrail for each 88-in (2,235.2 mm) of required width. Intermediate handrails shall be spaced approximately equal within the entire width of the stairway.

**EXCEPTION NO. 2:** Stairways serving one individual dwelling unit in Group R, Division 1 or 3 Occupancies may have one handrail, except that such stairways open on one or both sides shall have handrails provided on the open side or sides.

**EXCEPTION NO. 3:** Private stairways 30-in (762.0 mm) or less in height may have handrails on one side only.

**EXCEPTION NO. 6:** The provisions of subsection 2-3305 (j) 1 shall not apply to existing, privately-funded, apartment houses except when otherwise required under conditions applicable to access for the handicapped. Such existing building shall, however, conform to the provisions of Section 3305 (j), UBC.

Stairways

**2 Handrail Configuration.**

**A.** Handrails shall be 30-in to 34-in (762.0 to 863.6 mm) above the nosing of the treads.

**B.** Handrails shall extend a minimum of 12-in (304.8 mm) beyond the top nosing and 12-in (304.8 mm) plus the tread width beyond the bottom nosing.

**C.** Ends shall be returned or shall terminate in newel posts or safety terminals.

**D.** Where the extension of the handrail in the direction of the stair run would create a hazard, the extension shall be made at right angles, on the face of a returning wall. Where the stairs are continuous from landing to landing, the inner rail shall be continuous and need not extend out into the landing.

**E.** Handrails projecting from a wall shall have a space of not less than 1½-in (38.1 mm) between the wall and the handrail.

**F.** The handgrip portion of handrails shall be not less than 1¼-in (31.75 mm) nor more than 2-in (50.8 mm) in cross-sectional dimension or the shape shall provide an equivalent gripping surface and shall have a smooth surface with no sharp corners.

Handrails

The stairway requirements in these standards effectively apply only to public stairways in an apartment building which are used as a public means of egress. However, when such stairways do exist, they should be clearly marked at their upper and lower ends by handrail extensions and safety striping to let someone with poor vision know when they start and stop. (Figures 14,15,16). The handrail should be detailed to allow firm grip by those who need support. (Figure 17)

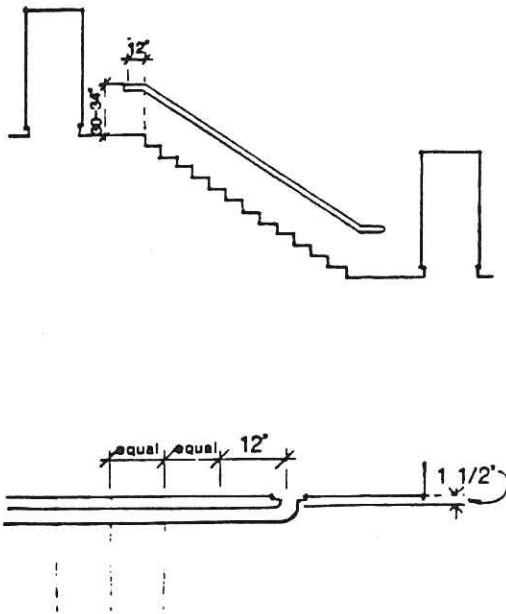

Figure 14  
rail extension

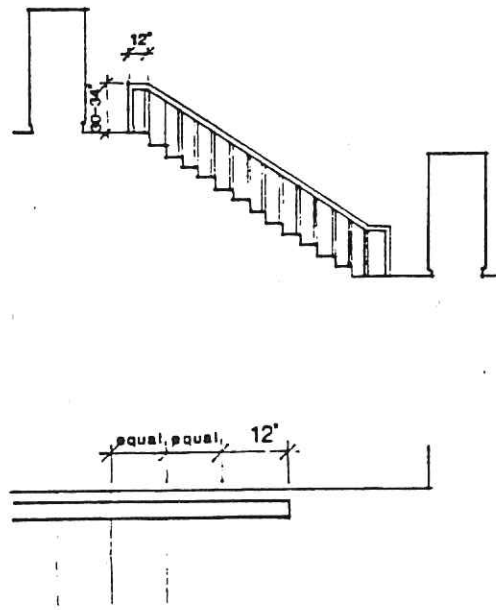

Figure 15  
newel post

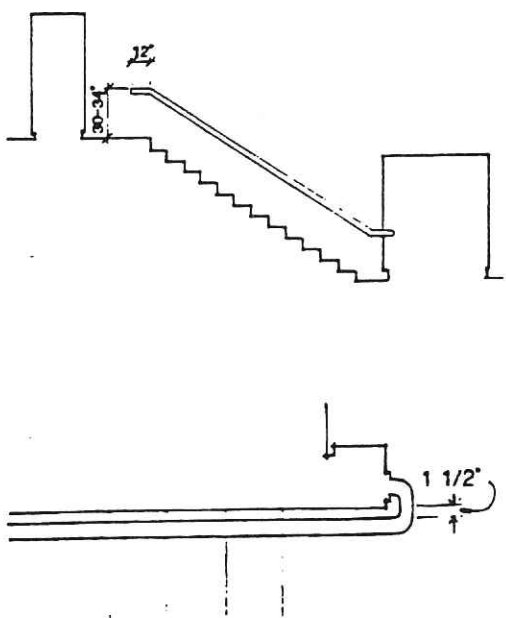

Figure 16  
corner return

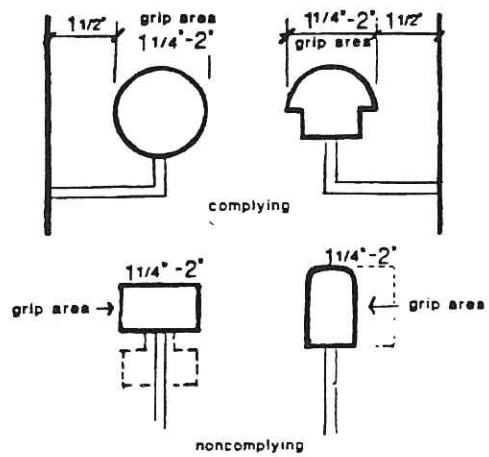

Figure 17  
rail grip area  
measured at horizontal

**Landings.** Ramp landings shall be installed as follows:

1. Location of landings shall be provided at the top and bottom of each ramp. Intermediate landings shall be provided at intervals not exceeding 30-in (762.0 mm) of vertical rise and at each change of direction. Landings are not considered in determining the maximum horizontal distance of each ramp.

NOTE: Examples of ramp dimensions are:

<i>Slope</i>	<i>Max. Rise (in.)</i>	<i>Max. Horizontal Projection (ft.)</i>
1:12	30 (762.0mm)	30 (9.144m)
1:16	30 (762.0mm)	40 (12.192m)
1:20	30 (762.0mm)	50 (15.240m)

## Landings

2. **Size of Top Landings.** Top landings shall be not less than 60-in (1,524.0 mm) wide and shall have a length of not less than 60-in (1,524.0 mm) in the direction of ramp run.
3. **Encroachment of Doors.** Doors in any position shall not reduce the minimum dimension of the ramp landing to less than 42-in (1,066.8 mm) and shall not reduce the required width by more than 3½-in (88.9 mm) when fully open.

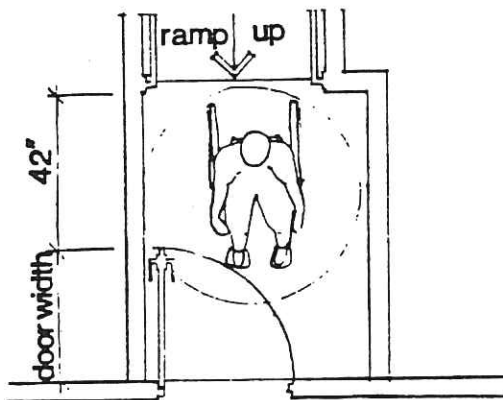

Figure 18  
door opens onto landing

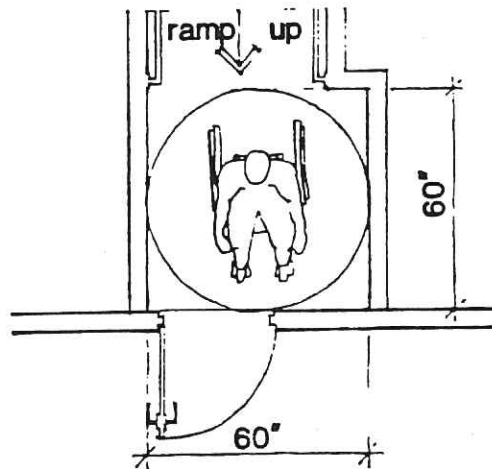

Figure 19  
door opens away from landing

When ramps are used the upper landing should be designed large enough to allow a person in a wheelchair to get to the top of the ramp, catch his breath and take a position to open a door. If the door opens out to the landing (Figure 18) a person should be allowed enough room to be on the landing even if another person opens the door out at the same time. When a door opens away from the landing enough room should be allowed for a person in a wheelchair to turn around and close the door behind him on the way out. (Figure 19)

2-3303(i) 2D

NH A-12

D. The space between two consecutive door openings in a vestibule, serving other than a required exit stairway shall provide a minimum of 48-in (1,219.20 mm) of clear space from any door opening into such vestibule when the door is positioned at an angle of 90 degrees from its closed position. Doors in a series shall swing either in the same direction or away from the space between the doors.

Vestibule

In vestibules where doors occur in series enough room is necessary to pass through one door and take a position to open the next one without worrying about being hit by another person opening the first door again. (Figure 20)

2-3303(i) 2C

NH A-12

C. The width of the level area on the side to which the door swings shall extend 24-in (609.60 mm) past the strike edge of the door for exterior doors and 18-in (457.20 mm) past the strike edge for interior doors.

Adjacent Space

When taking a position in a wheelchair to open a door one must let it swing by. Adequate space beside the door is necessary (Figure 21). The exterior door needs 24" alongside the lever edge to ensure that no unplanned obtrusions such as trash cans, parked cars, etc. impede the placement of the wheelchair beside the door. It is assumed that within the apartment an individual will keep the necessary floor area clear for the narrower front wheelbase (17" s.) for positioning the wheelchair.

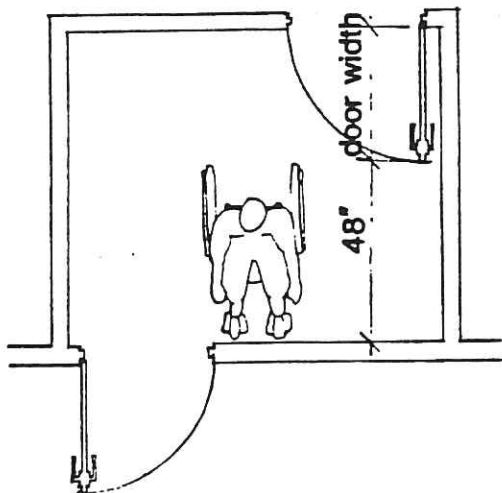

Figure 20  
vestibule

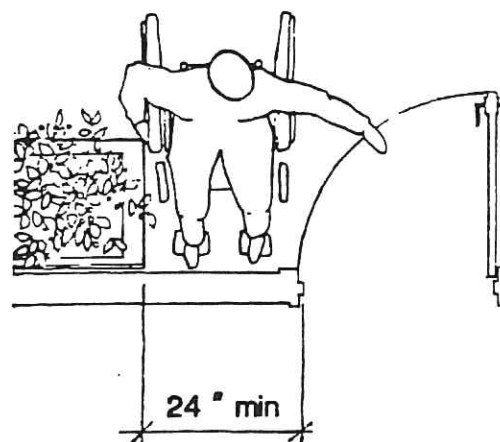

Figure 21  
exterior door opening  
adjacent space

2-3303(e) 1

NH A-11

- 1. **Door Size.** Every required exit doorway shall be of a size as to permit the installation of a door not less than 3 ft (914.4mm) in width and not less than 6 ft, 8-in (1.8288 m, 203.2 mm) in height. When installed in exit doorways, exit doors shall be capable of opening at least 90 degrees and shall be so mounted that the clear width of the exitway is not less than 32-in (812.8 mm).

Door opening

To pass through a door opening in a wheelchair which may be 28" wide without scraping knuckles, door or jamb, the clear width has to be at least 32" (Figure 22). This allows 2 extra inches on each side of the wheelchair, barely adequate, especially when turning 90 degrees from a corridor. Public corridors need to be wide enough for others to pass by and to turn around if desired. (Figure 23).

2-3303(i) 2A

NH A-11

- A. There shall be a level and clear area on each side of an exit door and 44-in (1,117.6 mm) where the door swings away from the level and clear area. The level area shall have a length of at least 60-in (1,524.0 mm) in the direction of door swing as measured at right angles to the plane of the door in its closed position.
  - EXCEPTION NO. 1:** In Group R, Division 3 Occupancies and within individual units of Group R, Division 1 Occupancies, a door may open on the top step of a flight of stairs or an exterior landing, provided the door does not swing over the top step or exterior landing and the landing is not more than 7½-in (190.5 mm) below the floor level.
  - EXCEPTION NO. 2:** In Group R, Division 3 Occupancies, screen doors and storm doors may swing over stairs or steps.
  - EXCEPTION NO. 3:** In Group R, Division 3 Occupancies and private garages and sheds where a door opens over a landing, the landing shall have a length equal to the width of the door.

Exterior level area

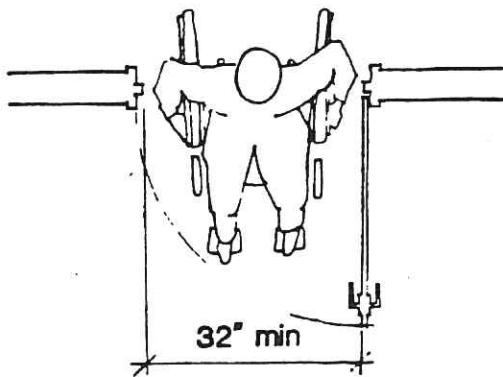

Figure 22  
door opening

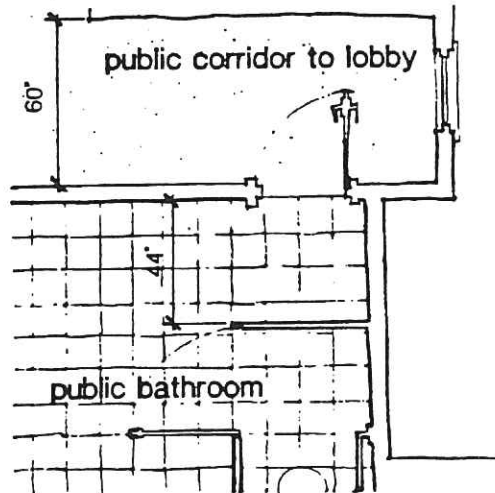

Figure 23  
exterior level area

The floor or landing on each side of an exit door shall be level. The level area shall have a length in the direction of door swing of at least 60-in (1,524.0 mm) and the length opposite the direction of door swing of 44-in

**EXCEPTION:** In Group R Occupancies, the level area shall have a length both in the direction of door swing and opposite the direction of door swing of 44-in (1,117.60 mm) as measured at right angles to the plane of the door in its closed position.

- C. The width of the level area on the side to which the door swings shall extend 24-in (609.60 mm) past the strike edge of the door for exterior doors and 18-in (457.20 mm) past the strike edge for interior doors.
- D. The space between two consecutive door openings in a vestibule, serving other than a required exit stairway shall provide a minimum of 48-in (1,219.20 mm) of clear space from any door opening into such vestibule when the door is positioned at an angle of 90 degrees from its closed position. Doors in a series shall swing either in the same direction or away from the space between the doors.

In apartment hallways where traffic patterns are quieter, enough room is needed to pivot the wheelchair through the door opening without scraping the opposite wall (Figure 24).

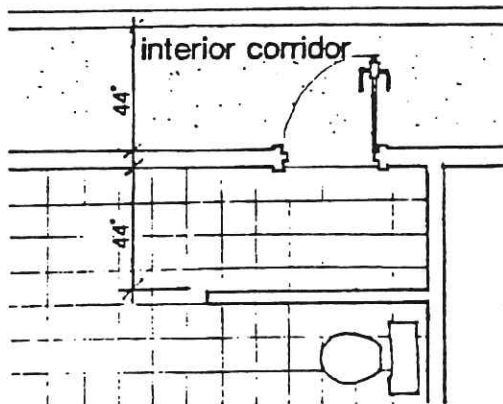

Figure 24  
level area Group R



# Height Components of Regulations

2-1213(b) 3,4

NH A-6

- Countertops. A minimum linear length of 30-in (762 mm) of countertop shall be provided for the kitchen sink and a minimum linear length of 30-in (762 mm) of countertop shall be provided for a work surface, both of which shall be designed to enable repositioning to a minimum height of 28-in (711.2 mm). The sink and work surface may be a single integral unit, or be separate components. The base cabinets directly under sink and work surface counter areas which are designed for repositioning shall be removable to provide clearance for a wheelchair.  
The sides and back of adjacent cabinets, which may become exposed to moisture or food handling when a countertop is lowered, shall be constructed of durable, nonabsorbent materials appropriate for such uses. Finished flooring shall be installed on the floor beneath such countertop.  
**EXCEPTION:** Stone, cultured stone and tiled countertops may be used without meeting the repositioning requirements.
- Lower Shelving. Lower shelving and or drawer space shall be provided in the kitchen at a height of no more than 48-in (1219.2 mm).

Counters/shelving

also see sections 3-210-25 & 3-380-8(c) of electrical code. NH A-18

Using an apartment from a wheelchair, where not only upper reach is lower but also eye level, careful consideration must be taken to assure that a correct thermostat setting can be made, switches and electrical receptacles can be reached and storage can be gotten to (Figure 25).

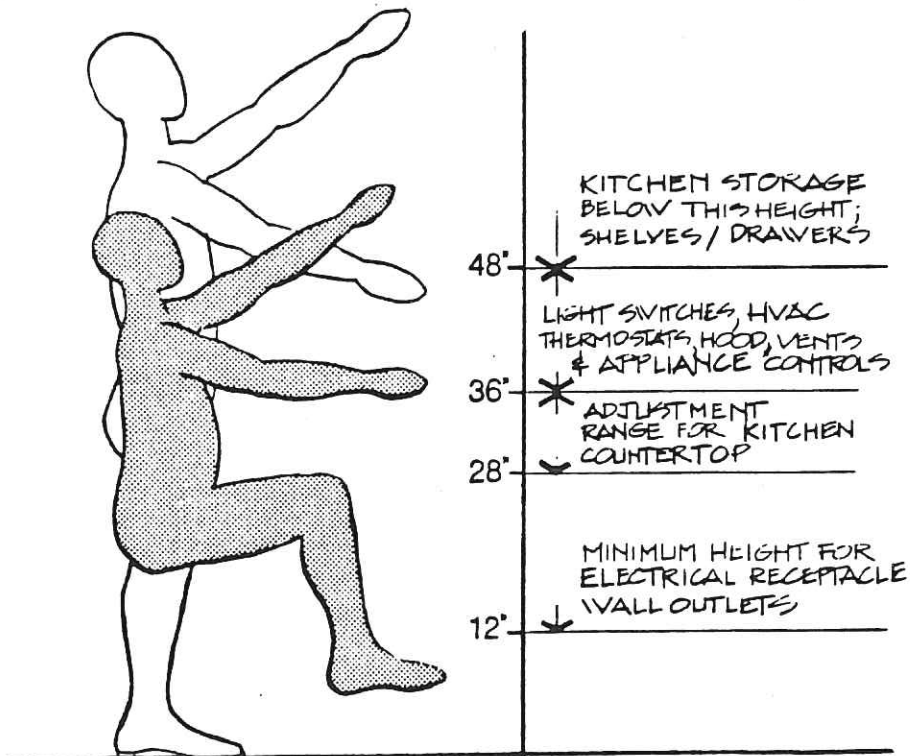

Figure 25  
seated and standing range of motion

## Bathroom Components of Regulations

A bathroom's fixtures--sink, toilet, and tub or shower--are points of activity which need correct height, width, and clear floor space in order to be comfortably used.

Whether able-bodied or disabled, a person wants to wash his or her face without getting everything else wet, to comb hair in the mirror, to get onto a toilet without bumping against a side wall or falling too quickly onto the seat, to get safely into a tub to take a bath or shower, and to dry off outside.

The space a wheelchair needs to position properly can usually be with a 30"X48" rectangle. The "landing" space is necessary to all fixtures because of the state of the art of wheelchair maneuverability. At both the tub and toilet if a wheelchair is not positioned optimally, there is an increased chance the user will fall during transfer while both arms are extended supporting the body swinging through space.

The 30"X48" rectangle can overlap other spaces. Making a bathroom large will not necessarily improve it. The placement of a lavatory next to the tub does not impede wheelchair movement if the bottom of the front lip is high enough (27 inches) to allow knee movement beneath it.

2-1213(d) 3

NH A-7

**Bathtubs.** There shall be a minimum space 48-in (1219.2 mm) parallel by 30-in (762 mm) perpendicular to the side of a bathtub or bathtub-shower combination to provide for the maneuvering of a wheelchair and transfer to and from the bathing facilities, which may include the maneuverable area under the lavatory.

Bathtub

The clear space beside the tub is important not only for transfer but for adjusting water controls. (Figure 26)

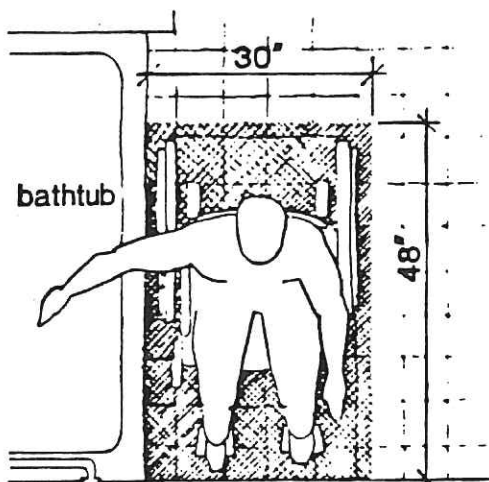

Figure 27

bathtub maneuvering space

2-1711(i) 1A

NH A-8

A clear floor space 30-in x 48-in (762 mm x 1219.2 mm) complying with Section 2-1722, shall be provided in front of a lavatory to allow a forward approach. Such clear floor space shall adjoin or overlap an accessible route and shall extend into knee and toe space underneath the lavatory.

Lavatory

The lavatory is at least 17 inches to the front edge to accommodate a seated person who wants to face directly ahead without splashing water into the lap (Figure 27).

The controls are no more than 19 inches from the front to be reachable.

2-1213(d) 4

NH A-7

Water Closets. The water closet shall conform to the provisions of Section 3-1502 (Part 5 of Title 24). The water closet may be located in a space 36-in (914.4 mm) in clear width with 48-in (1219.2 mm) of clear space provided in front of the water closet. This space may include maneuverable space under a lavatory, arranged so as not to impede access. Doors shall not infringe on the above clearances.

Water closet

The maneuvering space around a toilet cannot be overemphasized (Figure 28). Because of the number of possible transfers it is difficult to predict exactly what areas a tenant will utilize.

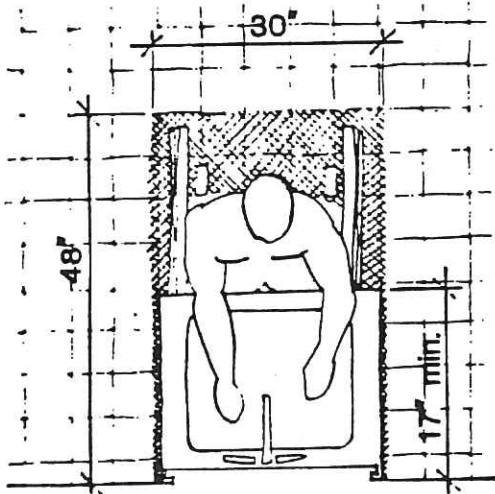

Figure 27  
lavatory space

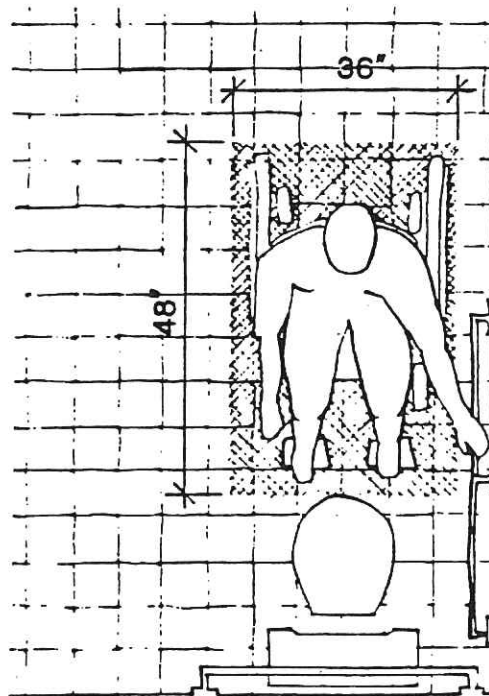

Figure 28  
water closet space

2-1213(d) 5

NH A-7

EXCEPTION NO. 5: Living accommodations need not provide grab bars provided support backing is installed to allow for future installations of grab bars.

Grab bars

2-1711(h) 1

NH A-7

Location. Grab bars located on each side, or one side of the back of the physically handicapped toilet stall or compartment shall be securely attached 33-in (838.2 mm) above and parallel to the floor. Grab bars at the side shall be at least 42-in (1066.8 mm) long with the front end positioned 24-in (609.6 mm) in front of the water closet stool and grab bars at the back shall be not less than 36-in (914.4 mm) long.

Grab bar backing let into studs around toilet and bathtub areas allow for future installation as needed at virtually no additional cost. By giving a useful height range in which to set future grab bars, this length of backing will help reduce the number one cause of household injury to elderly people, a fall in the bathroom (Figures 29,30).

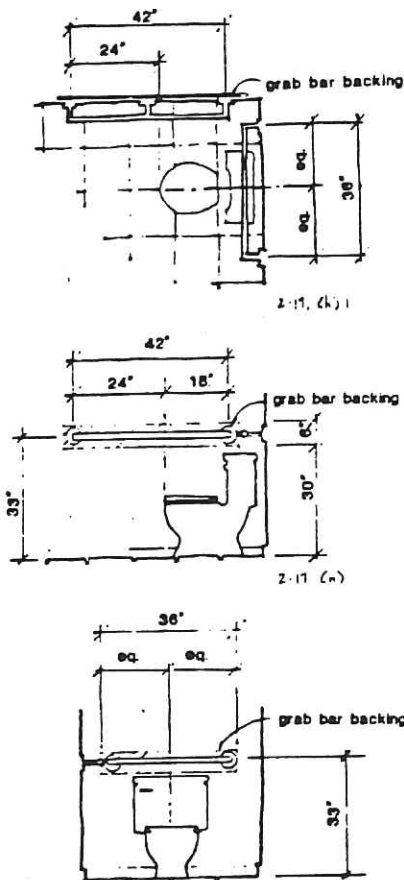

Figure 29  
grab bars & backing

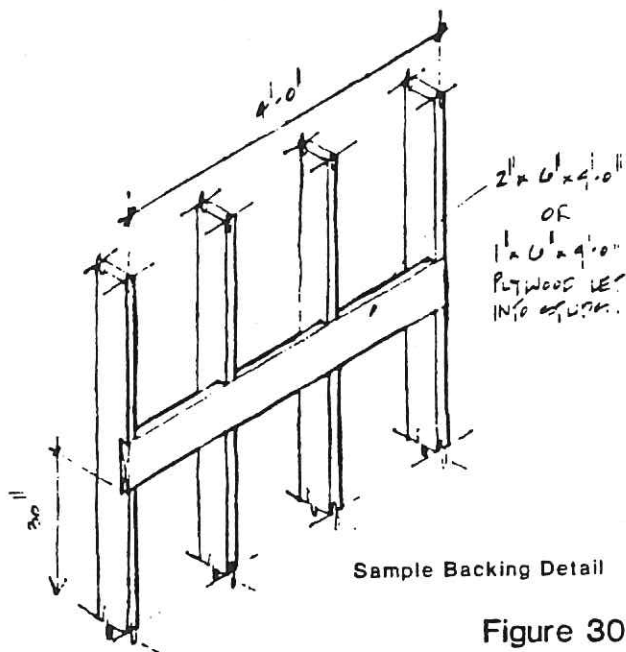

Figure 30

## TRANSFER TYPES

Three transfers are shown from a wheelchair onto a toilet seat (Figures 31,31,33). These transfers can all be made in the design optional for adaptable bathrooms shown (Figures 34,35,36).

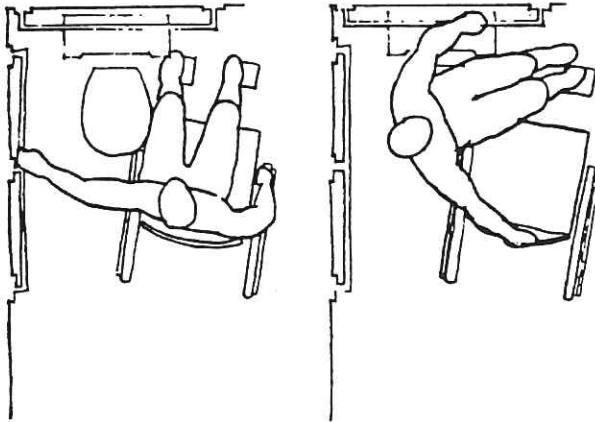

Figure 31  
type 1

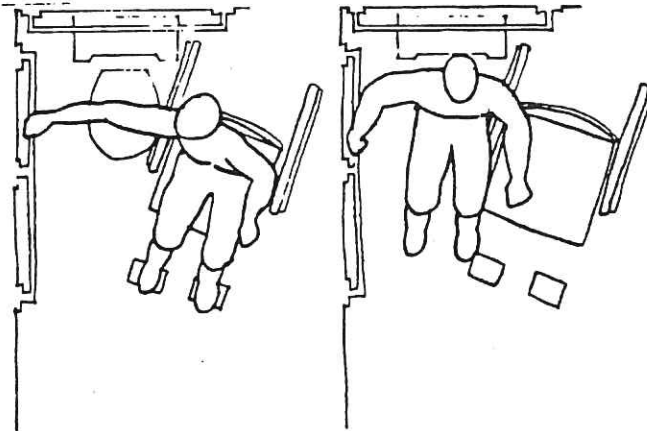

Figure 32  
type 2

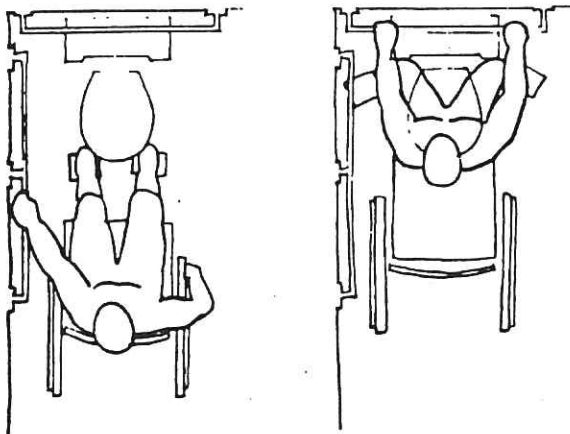

Figure 33  
type 3

# BATHROOM DESIGN OPTIONS

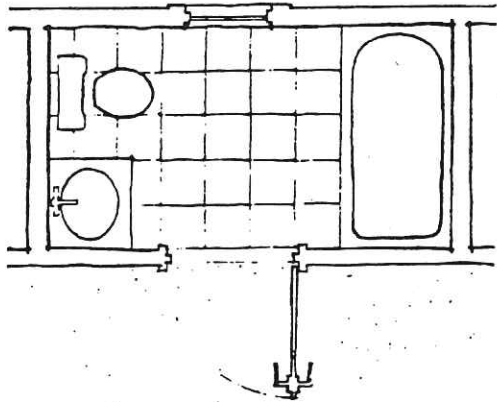

Figure 34

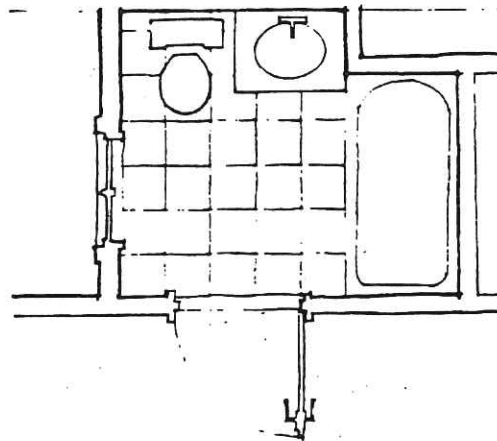

Figure 35

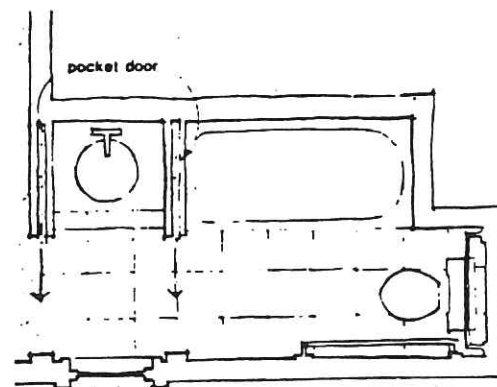

Figure 36

2-1711(j) A-C

NH A-8

- A. Compartments shall be 42-in (1066.8 mm) in width between wall surfaces and 48-in (1219.2 mm) in depth with an entrance opening width of 36-in (914.4 mm). Grab bars shall comply with subsection 2-1711 (h).
- B. When a threshold or recessed drop is used, it shall be a maximum of 1/4-in (12.7 mm) in height and shall be beveled or sloped at an angle not exceeding 45 degrees (100% gradient) from the horizontal.
- C. The shower floor shall slope toward the rear to a drain located within 6-in (152.4 mm) of the rear wall. Maximum slope of floor shall be 1/4-in (12.7 mm) per foot in any direction. The floor surfaces shall be of Carborundum or grit-faced tile or of material providing equivalent slip-resistance.

Showers

2-1215(d) 5

EXCEPTION NO. 2: Living accommodations need not provide folding shower seats in shower compartments provided support backing is installed to provide for future use of an adaptable unit.

If a compartment shower is used, it must be large enough to accommodate a wheelchair user, with backing provided to allow for the future installation of a seat to transfer into if desired (Figure 27). The 42"x48" floor area would give enough extra room to avoid damaging tile or fiberglass walls with the steel edges of the wheelchair.

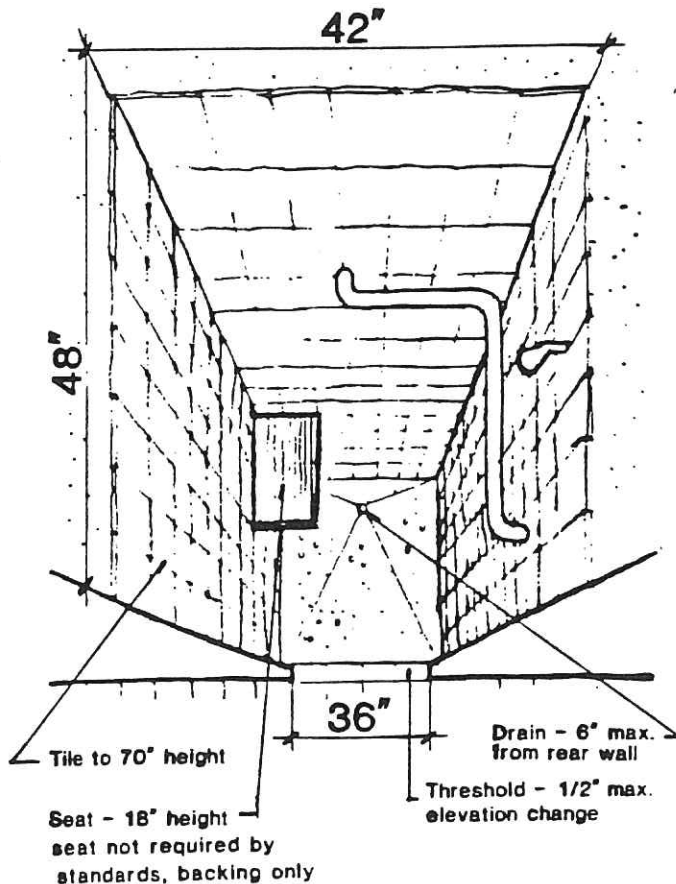

Figure 37  
compartment shower

## Kitchen Components of Regulations \_\_\_\_\_

The disabled and able-bodied have certain basic demands for a kitchen--appliances and storage spaces usable and reachable within a comfortable range of motion, adequate flat surfaces for preparation of meals, and quick clean-up of dishes and surrounding counter areas to maintain hygiene.

Designing for such kitchen use by the disabled and able-bodied should be thought out from the perspective of a standing person and one who is seated in a wheelchair. The seated person is lower and has a different center of gravity which makes a low reach more difficult. The wheelchair uses more floor space both at rest and maneuvering to a new position than would a standing or walking person.

A kitchen to suit a wide variety of users would provide storage for utensils, pots, dishes, and foodstuffs within comfortable reach, no more than 48 inches high, to be used by a seated person.

Switches for lights, temperature, fan, and appliance controls would be within 36" - 48" in height.

There would be adequate adjustment of work surfaces and sink area to prepare meals with the elbows lowered, between 28" - 36".

The lowest wall outlets would be no less than 12" above the floor. Eighteen inch outlets are more easily reached by a person whose seat is at 19", with arm extended to the side.

Both freezer and refrigerator should allow seeing as well as reaching of contents. Front controls for ranges and low mounted hood fan switches are helpful.

Dishwasher and oven doors which open to the side are easier to use by a seated person. Countertops immediately adjoining wall ovens allow for convenient transfer of heavy pots as they come out.

Attention to storage below 48" can maximize the usefulness of the kitchen. The four kitchen plans shown (galley, L-shaped, and two U-shaped) vary in floor area by only 1.5 square feet, but vary in lower storage from six linear feet to twenty-four feet (Figures 38,39,40,41).



2-1213(b) 2

NH A-6

Kitchens

Kitchens. Kitchens shall be designed and constructed to provide a minimum clear space of 60-in (1524 mm) between cabinet fronts, countertops, or walls for all U-shaped kitchen areas, and a minimum clear space of 48-in (1219.2 mm) for all other kitchen designs.

The distance between cabinet face and opposite wall/cabinet face differs from four feet for an L-shaped kitchen to five feet for a U-shaped kitchen because the doors of the base cabinets can be opened by a person in a wheelchair only when they can swing by. With cabinets on two sides of a U-shaped kitchen and the higher activity possible with more work surface and storage available, it would be difficult to efficiently use the space if constant wheelchair repositioning were necessary to get at the storage areas.

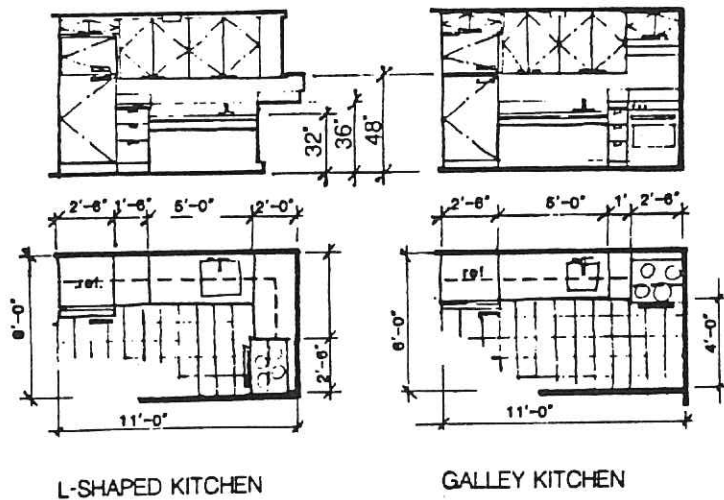

Figure 38

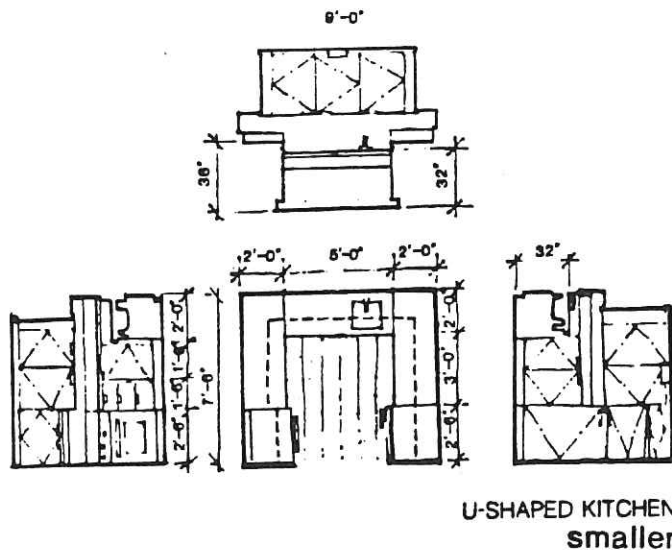

Figure 39

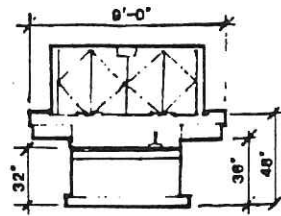
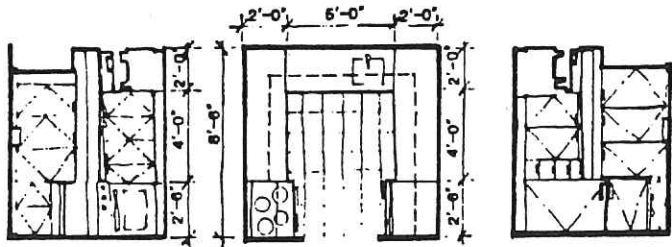

Figure 40



U-SHAPED KITCHEN  
larger

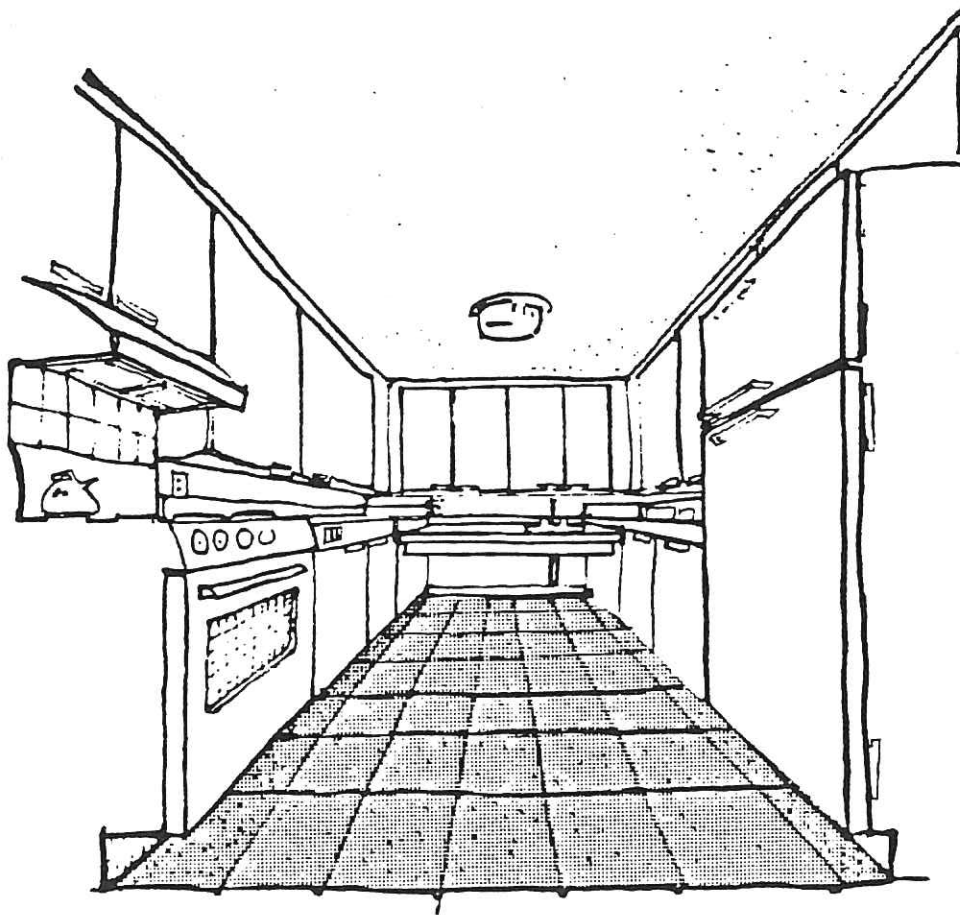

Figure 41  
u-shaped perspective

Countertops. A minimum linear length of 30-in (762 mm) of countertop shall be provided for the kitchen sink and a minimum linear length of 30-in (762 mm) of countertop shall be provided for a work surface, both of which shall be designed to enable repositioning to a minimum height of 28-in (711.2 mm). The sink and work surface may be a single integral unit, or be separate components. The base cabinets directly under sink and work surface counter areas which are designed for repositioning shall be removable to provide clearance for a wheelchair.

Lowerable counter

The sides and back of adjacent cabinets, which may become exposed to moisture or food handling when a countertop is lowered, shall be constructed of durable, nonabsorbent materials appropriate for such uses. Finished flooring shall be installed on the floor beneath such countertop. **EXCEPTION:** Stone, cultured stone and tiled countertops may be used without meeting the repositioning requirements.

Flat surfaces for food preparation and clean-up are designed to a 36 inch standard person of average height, but not for a shorter person, or one who is seated. The adjustable countertop for work and sink areas (28" - 36") covers a wide range of users. The 2'-6" length for each area allows a person in a wheelchair to draw under the counter as if sitting at a desk. Without this clear opening, the person would have to work turned sideways.

The adjustable area can be constructed like the rest of the countertop, including side and back splash board to control any surface water. One approach is to set the countertop on a 2x4 box with a fascia piece and use backing let into the rear and side walls for support (See Figure 42,43). When both work and sink area are combined, an adequate place for drying dishes will be on the same plane as the sink.

Finishing the floor to the wall under these adjustable areas maintains the life of the building longer than attempting to deal with individual changes as they arise.

illustrations on following page

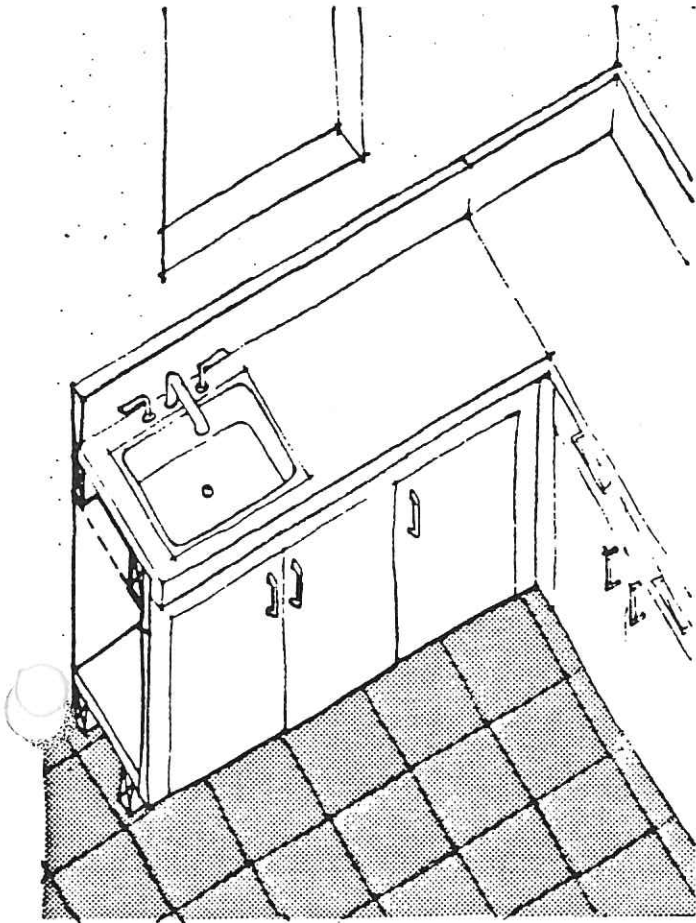

Figure 42  
counter up

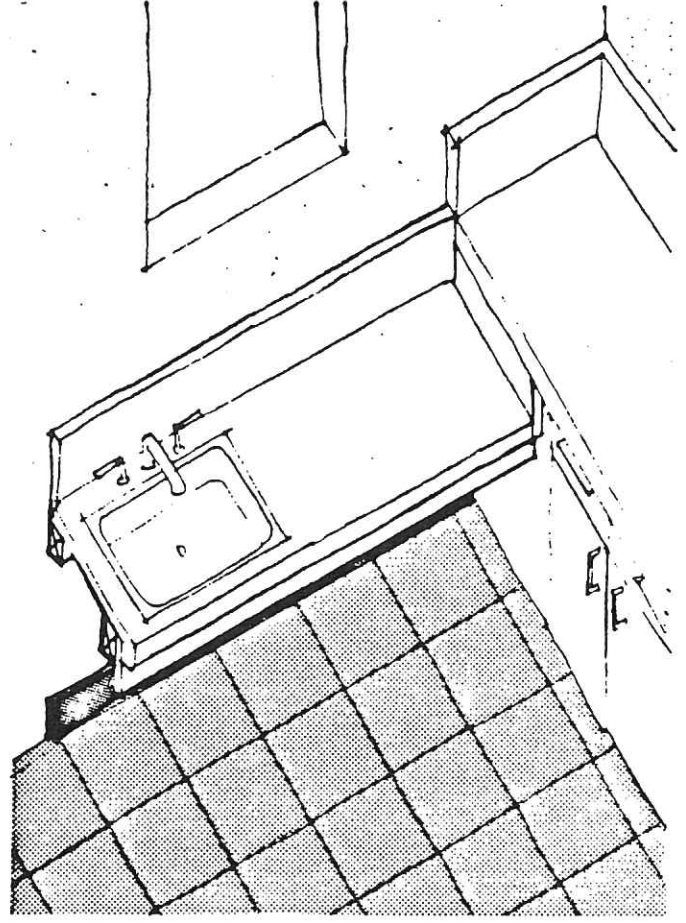

Figure 43  
counter down

## Typical Questions & Answers \_\_\_\_\_

**Q:** What elements qualify for the cost cap component of the standards?

**A:** The regulations contain an element which allows for a cost ceiling of approximately \$740. The cap states that a builder or developer need not spend more than this amount per adaptable dwelling unit. Adaptable units are those located on grade or accessible by ramp or elevator.

When calculating expenditures regarding the standards it is important that differential costs be calculated. For example, the total cost of lever door handles should not be included; only the difference in cost between knob handles and lever handles should be considered. Additional square footage required to meet the kitchen and bathroom space components of the standards may be considered, but the developer should be prepared to demonstrate that this square footage is greater than that found in nonadaptable units.

Site improvements, such as ramping are considered part of the costs that can be included in the cost cap. Design costs are not considered an allowable expense. An appropriate rule to follow in determining what qualifies for the cost cap is to include only those items which would not have been included in the unit were it not for the accessibility/adaptability regulations. The building permit applicant should be prepared to provide a thorough explanation of costs to the building department if a cost cap exemption is to be claimed. The cost cap is an expenditure ceiling; a builder is required to expend up to the ceiling for each adaptable unit.

**Q:** What is the definition of an apartment building?

**A:** An apartment building, as defined by the Uniform Building Code, contains three or more dwelling units.

**Q:** Do these regulations apply to condominiums?

**A:** During the initial formulation of the standards the Department of Housing and Community Development considered the inclusion of condominiums, but they are not affected by these standards.

Q: When considering a two-story apartment complex with five units on the first floor and five units on the second floor, how do I apply the standards?

A: The standards apply only to those apartment units which are accessible. Accessible means those units located at grade level or accessible by elevator or ramp.

Q: I have a four unit apartment building and a duplex on my site. The regulations state that all buildings on a site are considered as one building and that buildings of five units or more fall under the scope of these standards. How do I apply the regulations?

A: The intent of the regulations is that only apartment buildings are subject to the regulations (three units or more per building), therefore you would not be subject to these regulations because you have only four apartment units on your site.

Q: If I have further questions regarding these regulations, who should I contact?

A: Your building department should be able to provide assistance in clarifying the regulations. In addition the Department of Housing and Community Development may publish periodic bulletins which clarify the standards. Many professional associations such as CBIA and CALBO also have staff which are qualified to respond to questions regarding these regulations. If an individual is unable to receive a satisfactory response from these groups, the Department of Housing and Community Development will respond to inquiries about their regulations.

## A Note on Priorities

---

The new standards, although thorough, do not necessarily mean large additional construction costs. Most of the required design elements in apartments are matters of correct size and placement for standard items such as doors, switches, vanities, toilets and cabinets.

When additional costs are clearly present, it may be helpful to set priorities to get the most effect for money spent. Clearly, different individuals and groups may have different priorities, however, according to the California Association of the Physically Handicapped and other organizations the tenant's first priority is to enter the apartment and move freely through all its rooms, including bedrooms, and comfortably use storage areas. The door openings must be wide enough to avoid scraping wall or door surfaces by a wheelchair, and the hardware, whether lever, push type or other system, must be usable by a person with limited dexterity.

The second priority is to safely and comfortably use the bathroom--the toilet, vanity or lavatory, and the bathtub or shower. Adequate room is needed for wheelchair placement at all fixtures, backing in the walls is necessary around the toilet and bathtub for future grab bar emplacement if needed through careful placement of fixtures and using the same floorspace for different fixtures.

The third priority is maximizing kitchen use. For a person in a wheelchair or an able-bodied person this means food preparation, cooking meals, and cleaning up. Because a seated position is lower than a standing one, the height of countertops, sink storage areas and controls will determine what is comfortable and safe. Adequate floor space will be necessary to efficiently use different kitchen areas.

